

CURRENT SENSOR

PRODUCT SERIES: STK-HD/KS

PRODUCT SERIES: STK-20HD/KS
STK-32HD/KS
STK-40HD/KS
STK-50HD/KS

REVISION: Ver 1.2

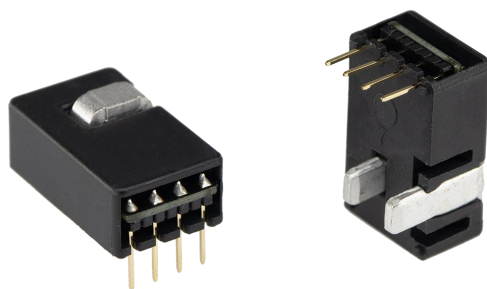

CONTENT

1.	Description	2
2.	Electrical performance of STK-20HD/KS	3
3.	Electrical performance of STK-32HD/KS	4
4.	Electrical performance of STK-40HD/KS	5
5.	Electrical performance of STK-50HD/KS	6
6.	Output voltage VS primary current of STK-HD/KS	7
7.	Frequency band width	9
8.	Step response time	9
9.	Delaytime	10
10.	Typical application circuits for STK-HD/KS	11
11.	Dimensions & Pins & Footprint	12

1. Description

STK-HD/KS current sensor is based on the open loop principle and TMR technology. DC, AC, pulses and any kind of irregularities wave can be measured by the current sensor under the isolated conditions.

Typical application

- AC Variable speed drives
- PV string current detection
- Switched model power supplies (SMPS)
- Direct-current dynamo
- MPPT

General parameters

Parameter	Symbol	Unit	Value
Working temperature	T _A	°C	-40 ~ 105
Storage temperature	T _{stg}	°C	-40 ~ 105
Mass	m	g	3.3

Absolute parameters

Parameters	Symbol	Unit	Value
Supply voltage	V _C	V	6
ESD rating (HBM)	U _{ESD}	kV	4

Remark: the unrecoverable damage may occur when the product works on the conditions over the absolute maximum ratings. Long-time working on the absolute maximum ratings may cause the degradation on performance and reliability.

Isolation parameters

Parameter	Symbol	Unit	Value	Remark
RMS voltage for AC test 50Hz/1 min	U _d	kV	4	
Impulse withstand voltage 1.2/50μs	Ū _w	kV	6	
Case material			V0 according to UL 94	
Comparative tracking index	CTI	V	600	

2. Electrical performance of STK-20HD/KS

Parameter	Symbol	Unit	Min	Typ	Max	Comment
Primary nominal current rms	I _{pn}	A		20		
Primary current measuring range	I _{pm}	A	-50		50	
Supply voltage	V _{cc}	V		3.3		
Current consumption	I _{cc}	mA		5	10	
Reference voltage	V _{ref}	V	1.63	1.65	1.67	Output function
Quiescent voltage V _{out} @ 0 A	V _{off}	V	1.63	1.65	1.67	
Electrical offset voltage (V _{out} – V _{ref}) @ 0 A	V _{oe}	mV	-8		8	
Rated output voltage ((V _{out} – V _{ref})@I _{pn}) – V _{oe}	V _{FS}	V		0.46		
Internal output resistance	R _{out}	Ω		10		
Internal reference resistance	R _{ref}	Ω		10		
Theoretical gain	G	mV/A		23		
Rated linearity error	Non-L	%I _{pn}		0.5		Within ±I _{pn}
Reaction time	t _{ra}	μs		0.5		@ 10% of I _{pn}
Step response time	t _{res}	μs		1.0		@ 90% of I _{pn}
Delay time	t _{delay}	μs		0.5		400 kHz sine wave
Frequency bandwidth (-3dB)	BW	kHz		600		No RC circuit
Output voltage noise DC ~ 10 kHz DC ~ 100 kHz	V _{noise}	mVpp		8 10		@250kHz Sampling Rate
Accuracy @ 25°C	X	% of I _{pn}	-0.8		0.8	@ 25°C
Accuracy @ -40°C~105°C	X _{TRange}	% of I _{pn}	-1.5		1.5	-40°C ~ 105°C

Remarks:

- the accuracy @ -40°C~105°C, X_{TRange} = (((V_{out} – V_{ref})@ I_n @ T_x) – V_{oe}@ 25°C – G_{th} * I_n) / V_{FS}, where T_x represents present temperature, G_{th} is fitted gain at room temperature.

3. Electrical performance of STK-32HD/KS

Parameter	Symbol	Unit	Min	Typ	Max	Comment
Primary nominal current rms	I _{pn}	A		32		
Primary current measuring range	I _{pm}	A	-80		80	
Supply voltage	V _{cc}	V		3.3		
Current consumption	I _{cc}	mA		5	10	
Reference voltage	V _{ref}	V	1.63	1.65	1.67	Output function
Quiescent voltage V _{out} @ 0 A	V _{off}	V	1.63	1.65	1.67	
Electrical offset voltage (V _{out} – V _{ref}) @ 0 A	V _{oe}	mV	-8		8	
Rated output voltage ((V _{out} – V _{ref})@I _{pn}) – V _{oe}	V _{FS}	V		0.46		
Internal output resistance	R _{out}	Ω		10		
Internal reference resistance	R _{ref}	Ω		10		
Theoretical gain	G	mV/A		14.3		
Rated linearity error	Non-L	%I _{pn}		0.5		Within ±I _{pn}
Reaction time	t _{ra}	μs		0.5		@ 10% of I _{pn}
Step response time	t _{res}	μs		1.0		@ 90% of I _{pn}
Delay time	t _{delay}	μs		0.5		400 kHz sine wave
Frequency bandwidth (-3dB)	BW	kHz		600		No RC circuit
Output voltage noise DC ~ 10 kHz DC ~ 100 kHz	V _{noise}	mV _{pp}		8 10		@250kHz Sampling Rate
Accuracy @ 25°C	X	% of I _{pn}	-0.8		0.8	@ 25°C
Accuracy @ -40°C~105°C	X _{TRange}	% of I _{pn}	-1.5		1.5	-40°C ~ 105°C

Remarks:

- the accuracy @ -40°C~105°C, X_{TRange} = (((V_{out} – V_{ref})@ I_n @ T_x) – V_{oe}@ 25°C – G_{th} * I_n) / V_{FS}, where T_x represents present temperature, G_{th} is fitted gain at room temperature.

4. Electrical performance of STK-40HD/KS

Parameter	Symbol	Unit	Min	Typ	Max	Comment
Primary nominal current rms	I _{pn}	A		40		
Primary current measuring range	I _{pm}	A	-100		100	
Supply voltage	V _{cc}	V		3.3		
Current consumption	I _{cc}	mA		5	10	
Reference voltage	V _{ref}	V	1.63	1.65	1.67	Output function
Quiescent voltage V _{out} @ 0 A	V _{off}	V	1.63	1.65	1.67	
Electrical offset voltage (V _{out} – V _{ref}) @ 0 A	V _{oe}	mV	-8		8	
Rated output voltage ((V _{out} – V _{ref})@I _{pn}) – V _{oe}	V _{FS}	V		0.46		
Internal output resistance	R _{out}	Ω		10		
Internal reference resistance	R _{ref}	Ω		10		
Theoretical gain	G	mV/A		11.5		
Rated linearity error	Non-L _{pn}	%I _{pn}		0.5		Within ±I _{pn}
Reaction time	t _{ra}	μs		0.5		@ 10% of I _{pn}
Step response time	t _{res}	μs		1.0		@ 90% of I _{pn}
Delay time	t _{delay}	μs		0.5		400 kHz sine wave
Frequency bandwidth (-3dB)	BW	kHz		600		No RC circuit
Output voltage noise DC ~ 10 kHz DC ~ 100 kHz	V _{noise}	mV _{pp}		8 10		@250kHz Sampling Rate
Accuracy @ 25°C	X	% of I _{pn}	-0.8		0.8	@ 25°C
Accuracy @ -40°C~105°C	X _{TRange}	% of I _{pn}	-1.5		1.5	-40°C ~ 105°C

Remarks:

- the accuracy @ -40°C~105°C, X_{TRange} = (((V_{out} – V_{ref})@ I_n @ T_x) – V_{oe}@ 25°C – G_{th} * I_n) / V_{FS}, where T_x represents present temperature, G_{th} is fitted gain at room temperature.

5. Electrical performance of STK-50HD/KS

Parameter	Symbol	Unit	Min	Typ	Max	Comment
Primary nominal current rms	I _{pn}	A		50		
Primary current measuring range	I _{pm}	A	-125		125	
Supply voltage	V _{cc}	V		3.3		
Current consumption	I _{cc}	mA		5	10	
Reference voltage	V _{ref}	V	1.63	1.65	1.67	Output function
Quiescent voltage V _{out} @ 0 A	V _{off}	V	1.63	1.65	1.67	
Electrical offset voltage (V _{out} – V _{ref}) @ 0 A	V _{oe}	mV	-8		8	
Rated output voltage ((V _{out} – V _{ref})@I _{pn}) – V _{oe}	V _{FS}	V		0.46		
Internal output resistance	R _{out}	Ω		10		
Internal reference resistance	R _{ref}	Ω		10		
Theoretical gain	G	mV/A		9.2		
Rated linearity error	Non-L _{pn}	%I _{pn}		1		Within ±I _{pn}
Linearity error @ I _{pm}	Non-L _{pm}	%I _{pm}		3		±I _{pm}
Reaction time	t _{ra}	μs		0.5		@ 10% of I _{pn}
Step response time	t _{res}	μs		1.0		@ 90% of I _{pn}
Delay time	t _{delay}	μs		0.5		400 kHz sine wave
Frequency bandwidth (-3dB)	BW	kHz		600		No RC circuit
Output voltage noise DC ~ 10 kHz DC ~ 100 kHz	V _{noise}	mV _{pp}		8 10		@250kHz Sampling Rate
Accuracy @ 25°C	X	% of I _{pn}	-0.8		0.8	@ 25°C
Accuracy @ -40°C~105°C	X _{TRange}	% of I _{pn}	-1.5		1.5	-40°C ~ 105°C

Remarks:

- the accuracy @ -40°C~105°C, X_{TRange} = (((V_{out} – V_{ref})@ I_n @ T_x) – V_{oe}@ 25°C – G_{th} * I_n) / V_{FS}, where T_x represents present temperature, G_{th} is fitted gain at room temperature.

6. Output voltage VS primary current of STK-HD/KS

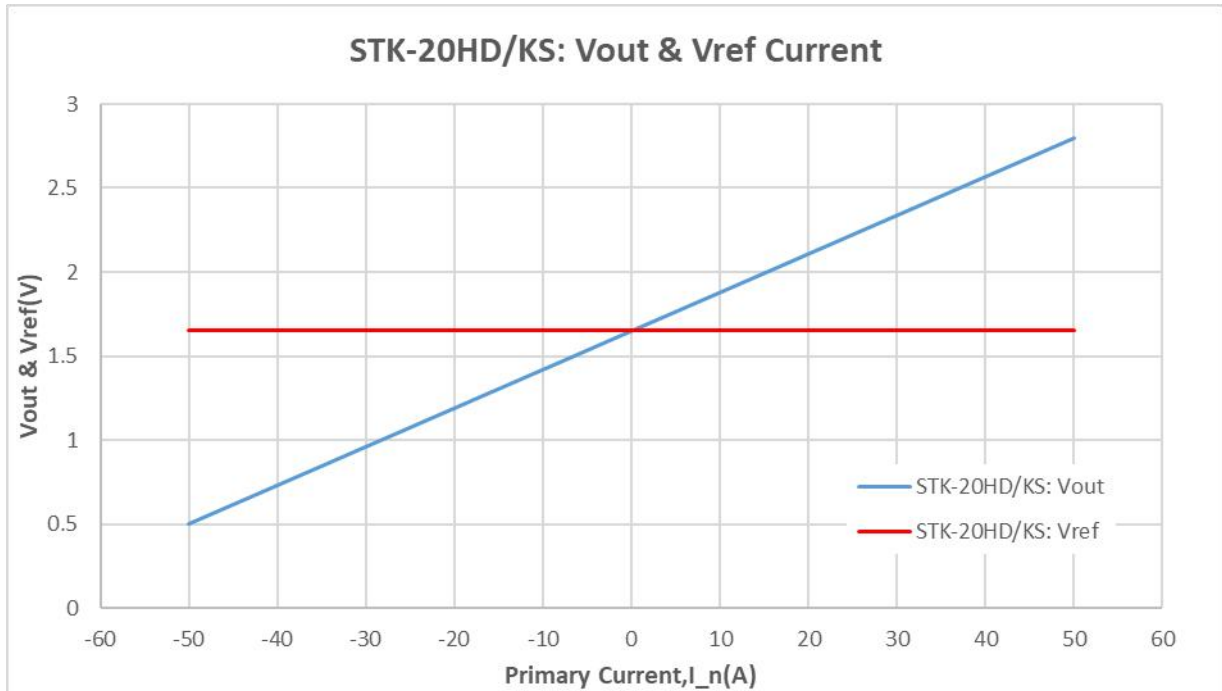

The dependence of Vout&Vref of STK-20HD/KS on the primary current.

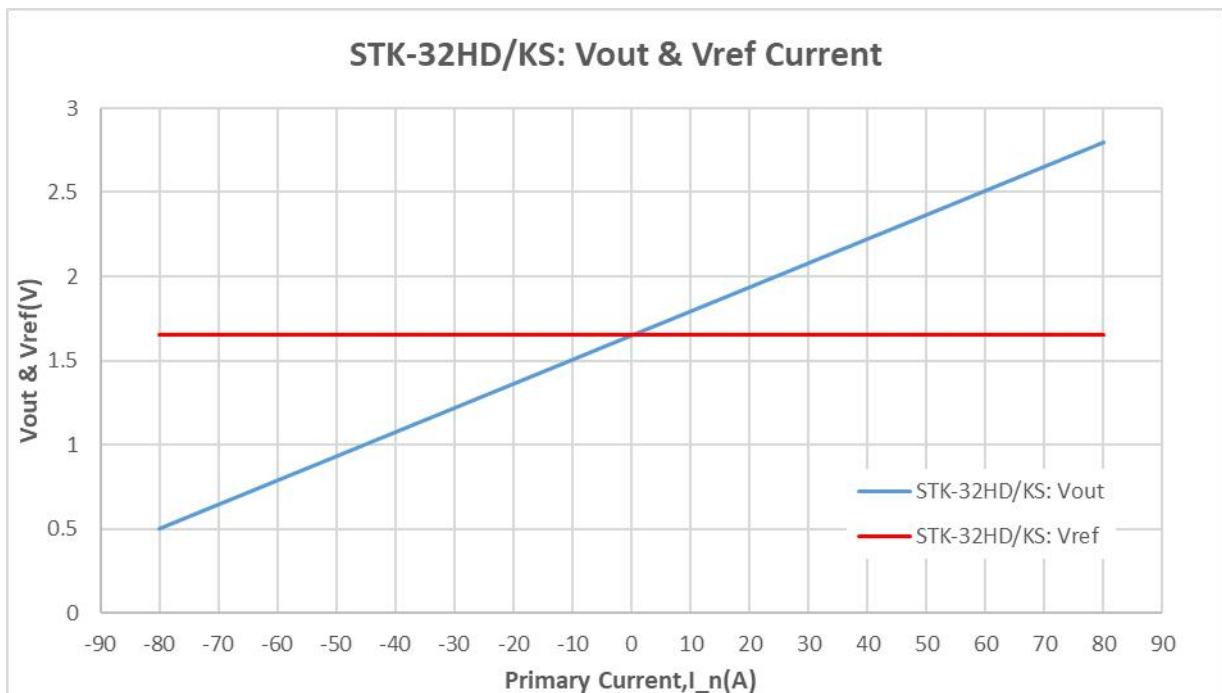

The dependence of Vout&Vref of STK-32HD/KS on the primary current.

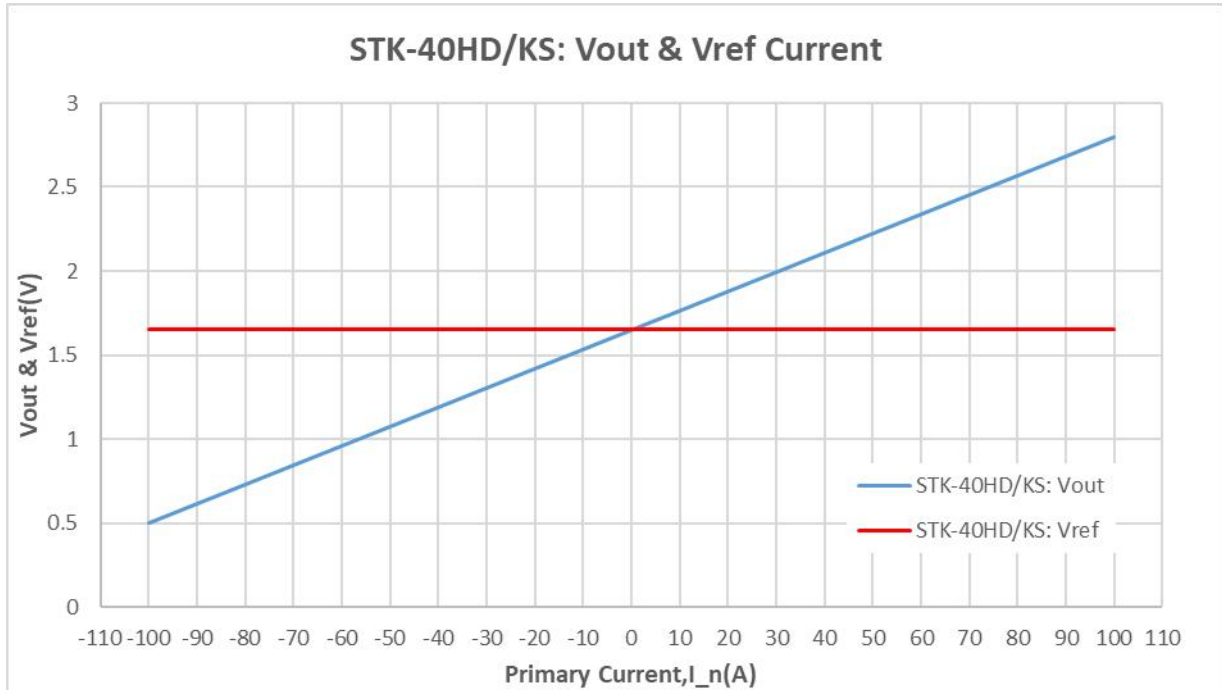

The dependence of Vout&Vref of STK-40HD/KS on the primary current.

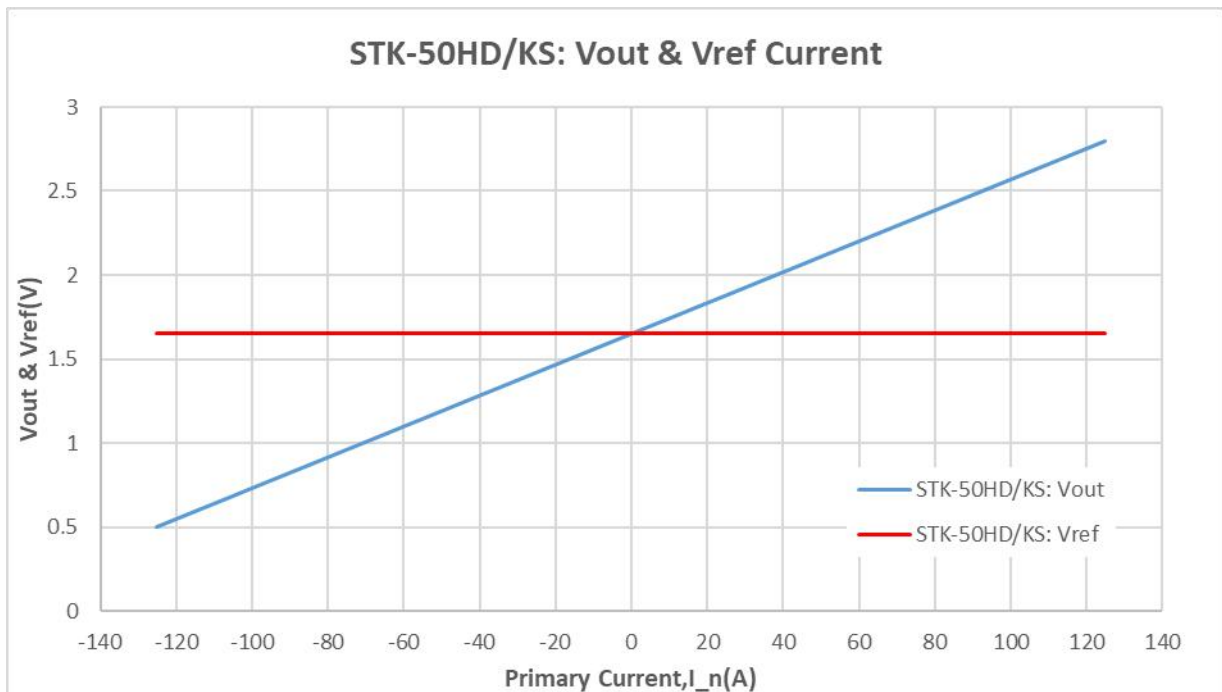

The dependence of Vout&Vref of STK-50HD/KS on the primary current.

7. Frequency band width

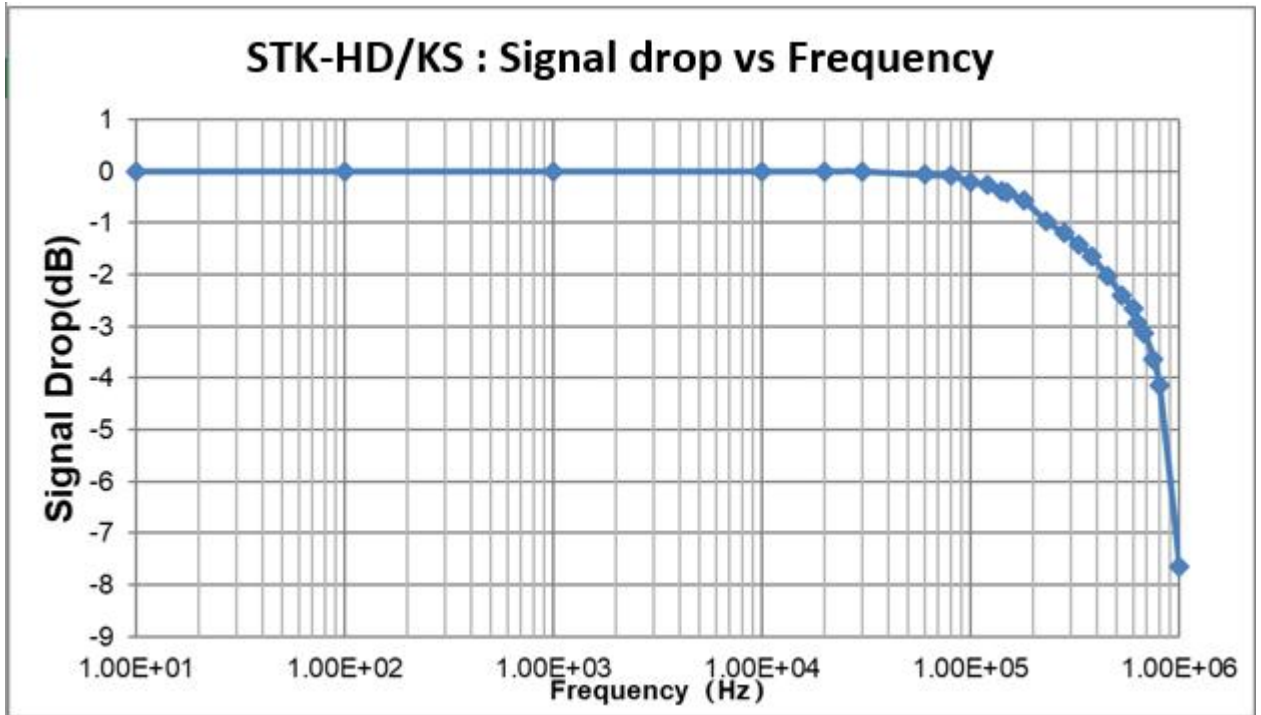

The frequency band width of STK-HD/KS series current sensors.

8. Step response time

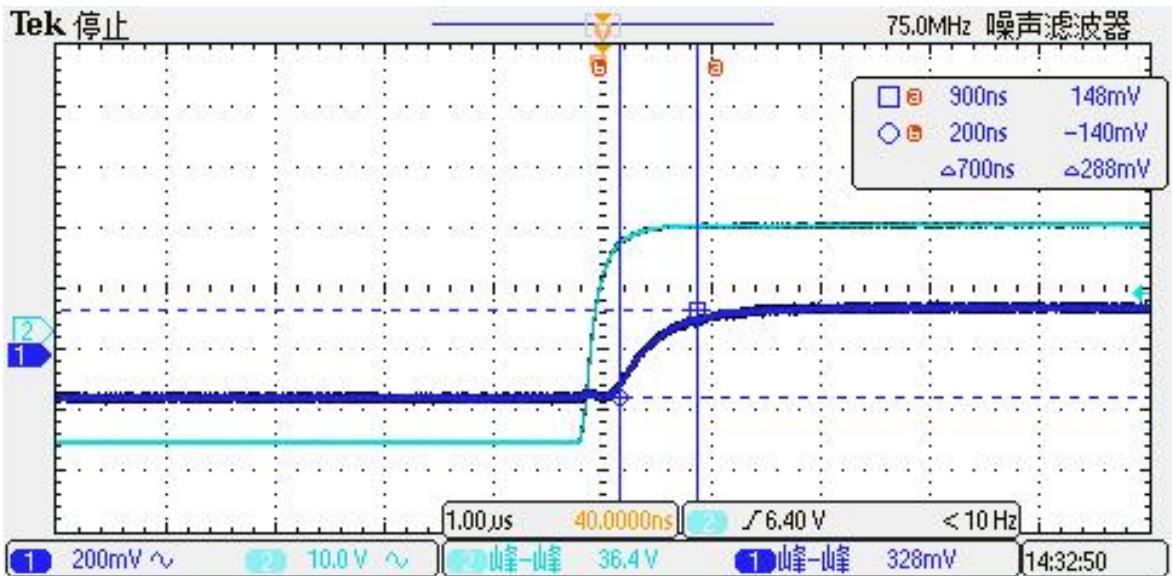

The step response time of STK-HD/KS current sensors. The light blue is primary current, while the dark blue is output signal of current sensor. The step response time is less than 1.0 μ s.

9. Delaytime

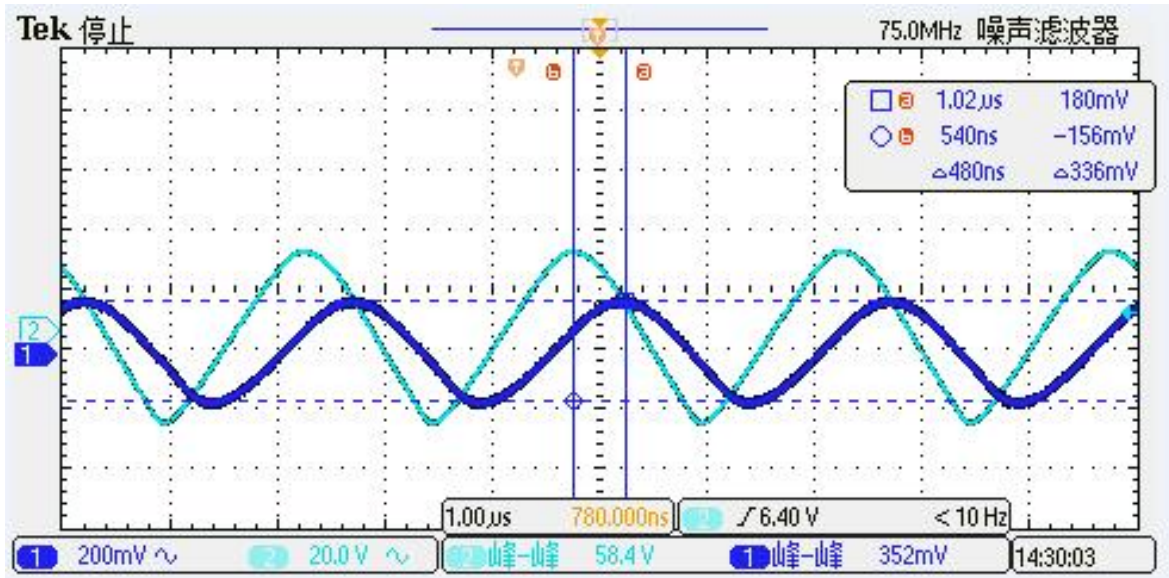

When detecting the primary current with a frequency of 400 kHz. The delay time from the primary current (light blue) to the output of the sensor (dark blue) is around 0.5 μ s.

10. Typical application circuits for STK-HD/KS

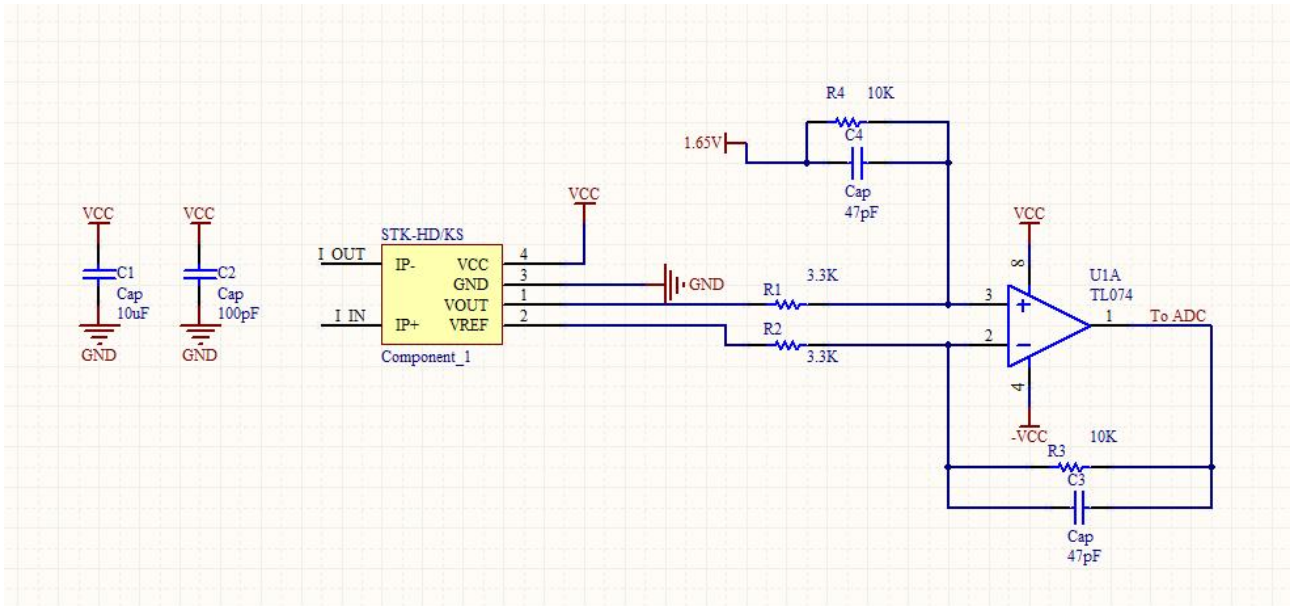

Typical application circuits for STK-HD/KS current sensor. The magnification can be estimated as $M = R4/R2$ with the condition of $R1 = R2$, and $R3 = R4$. The magnification in the above circuit is about 3.

R3 (kohm) = R4 (kohm)	C3 (pF) = C4 (pF)	Theoretical -3dB $f = 1/(2\pi RC)$ (kHz)	Tested -3dB (kHz)
20	20	398	~400
20	81	98	~100
20	810	10	~10

The frequency characteristics of STK_HD/KS series current sensor are not affected by the R-C setting (according to recommended R-C setting), therefore the active filter circuit or R-C circuit can be applied to modulate the sensor's frequency characteristics.

11. Dimensions & Pins & Footprint

